



**FIRE RATED
DOOR**



 **Octopus™**
FIRE DOOR

You Should Trust Us,

WHY

Company

Established in 2012, Octopus Marketing Sdn Bhd is a Malaysian company that specializes in manufacturing high quality fire rated core & fire rated doorset. Our goal is to provide our customer with the satisfaction of knowing that their property and whoever resides in it are in the highest fire protection.

Product - Octopus Fire Doorset & Solid Core Door

Commercial/High-Rise Use

Octo-Casper – 1 hour fire rating with metal frame – single & double leaves
Octo-Argus – 1 hour fire rating with timber frame – single & double leaves
Octo-Valgaris – 2 hour fire rating with metal frame – single & double leaves

Home Use – Bedroom & Kitchen

Octo-Blanket – solid core door with fire resistant features.

Vision

We aim to be the best in the product we produce and the services we render.

Mission

We aim to be the leading supplier of fire rated doorset and services of superior quality and value that improve the lives of the world's consumer, now and the generation to come.

Product Warranty

This is an important area for us, for customer loyalty and customer satisfaction, to stand behind our product not just though the 24 months product warranty period but beyond.

We want our customer remain to loyal to us, so that when they get into their next purchase cycle, they've had a good product experience with us.

Certification **SIRIM**

Our full range of fire rated door set are certified by SIRIM QAS International Sdn Bhd and complies to MS 1073: Part 3: 1996 (Amd 1 : 2003)

Licenses **BOMBA**

Our full range of fire rated doorset are approved by The Fire and Rescue Department of Malaysia.

Natural Cross Veneer Designer Door Collection

- Surface with 0.5mm Thk Natural Veneer laminated onto 3.2mm Thk tropical grade plywood based
- All in cross grain only
- Suitable for local climate condition.
- Additional cut of groove line and insert of stainless steel can be made
- Limited door sizes up to 3' x 8' SL and 6' x 8' DL only
- Thickness availability
48mm one hour fire rated door set
38mm solid door with fire resistant features
- Warranty 2 years



REEF 502



REEF 503



REEF 501



REEF 505



REEF 506



REEF 507



REEF 508



REEF 509

Reconstituted Engineered Veneer Door Collection

- 1 hour fire door c/w metal & timber frame
- Surface with 0.5mm Thk Reconstituted veneer overlayed onto 3.2mm Thk Tropical plywood based
- Contemporary design in quarter cut recon veneer in vertical and cross grain selection
- Suitable for interior use
- Available in vertical grain and cross grain
- Additional cut of groove line and insert of stainless steel can be made
- Thickness availability
48mm one hour fire rated door set
38mm solid door with fire resistant features
- Warranty 2 years

Important note : This door not suitable for external use. (expose to weather)



MAYA 303



MAYA 301



MAYA 3302

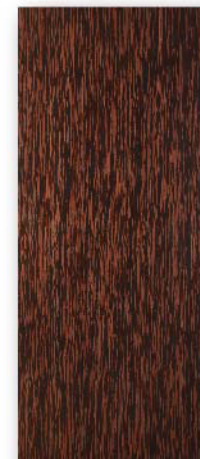

MAYA 305



MAYA 306



MAYA 307



MAYA 308

Plywood Flush Panel Designer Collection

Selection of Groof Line

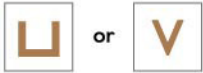

Contemporary design and affordable decorative flush panel door with shadow carved design to suit your taste.

- 1 hour fire rated door c/w metal or timber frame
- Surface with 3mm or 6mm Thk Plywood
- Plain smooth skin suitable for any enamel paint and any solid color paint
- Suitable for interior use only
- Suitable to local climate condition
- Custom additional insert of stainless steel lining can be made
- Door available in any sizes
- Thickness availability
48mm one hour fire rated door set
38mm solid door with fire resistant features
- Warranty 2 years

Important note : This door not suitable for external use. (expose to weather)

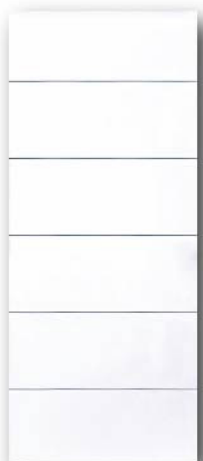

MIMIC 01



MIMIC 06



MIMIC 13



MIMIC 15

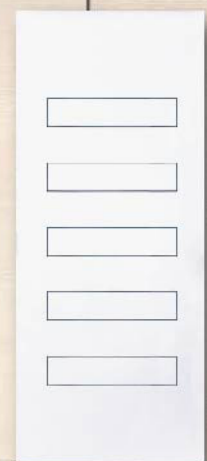

MIMIC 20

Front & Internal Elevation Of Doorset

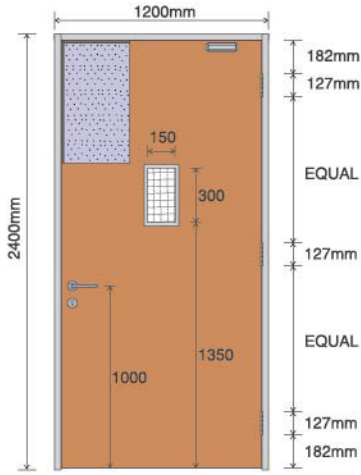

Vertical Section Of Doorset

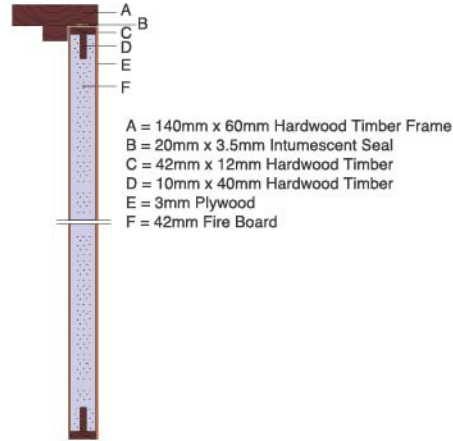

Profile Of Timber Frame
Model : Argus

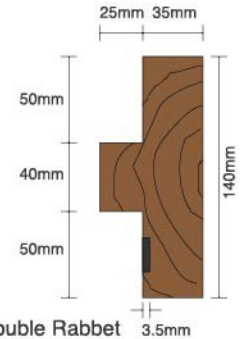
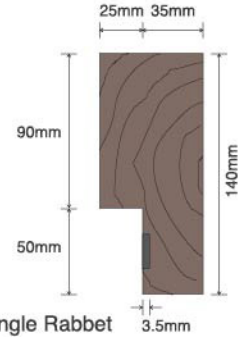

Front & Internal Elevation Of Doorset

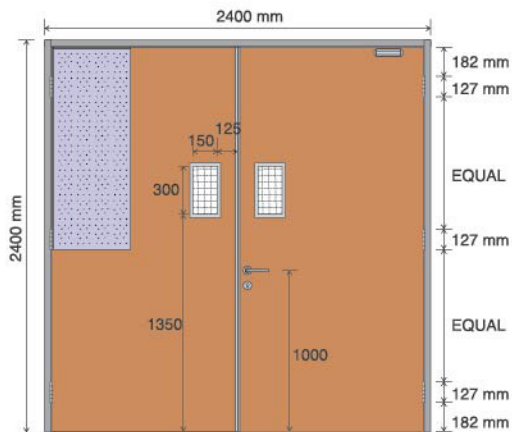

Horizontal Section Of Doorset

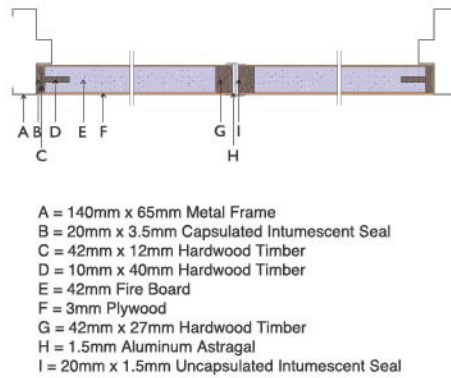

Profile Of Aluminum Astragal



Profile Of Metal Frame
Model : Casper

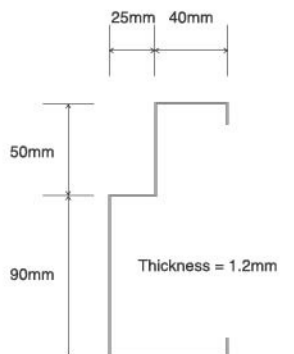
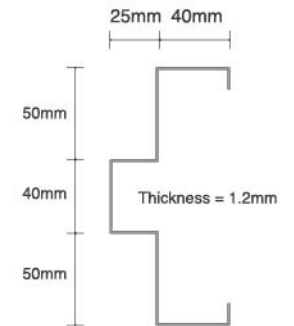

2 HOURS FIRE RATED DOORSET

Front & Internal Elevation Of Doorset
Model : Vulgaris

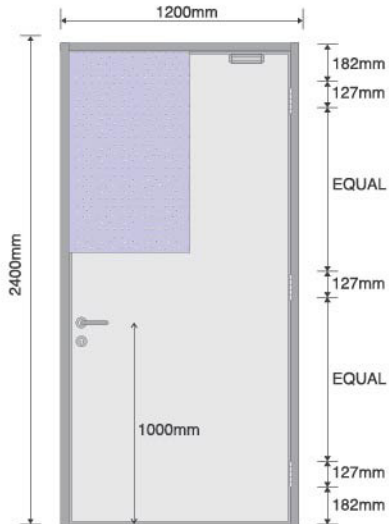

Vertical Section Of Doorset
Model : Vulgaris

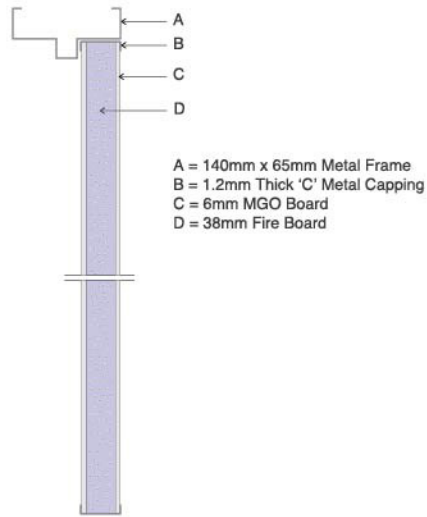

Profile Of Metal Frame
Model : Vulgaris

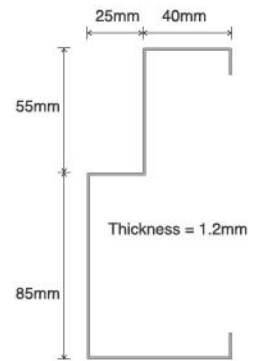

Front & Internal Elevation Of Doorset
Model : Vulgaris

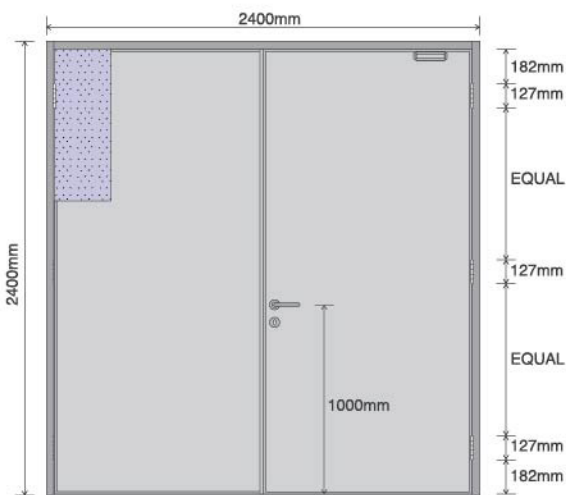

Horizontal Section Of Doorset
Model : Vulgaris

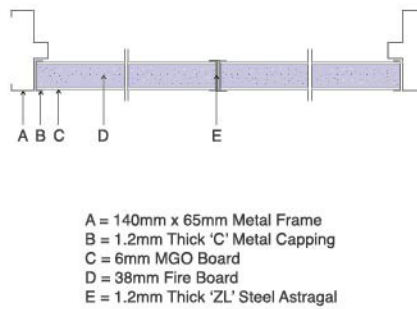

Profile Of Metal Frame
Model : Vulgaris

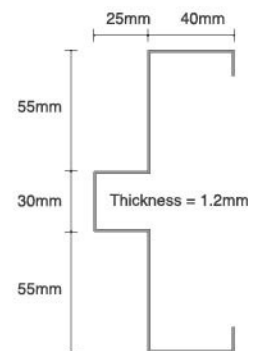

Lever Handle

KS 4201 001

Material : Stainless Steel SUS304



KS 4201 002

Material : Stainless Steel SUS304



KS 4201 003

Material : Stainless Steel SUS304



KS 4201 004 (optional)

Material : Stainless Steel SUS304



KS 4201 011 (optional)

Material : Stainless Steel SUS304



Euro Profile Cylinder



T19S65 THUMBTURN

Mortise Lock

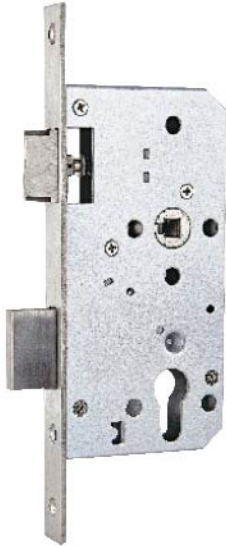

72 SERIES

Door Closer



72 V

Door Selector



DC-9402



DC-9403

Autobolt

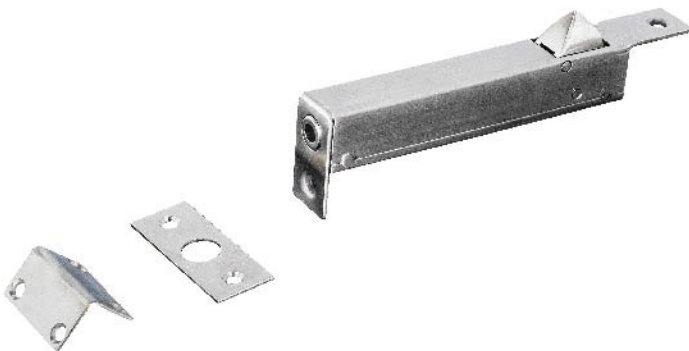

DA-9317

Hinges



DA-9315
(127mm x 89mm x 2.5mm)

OCTOPUS Fire Doors comply with stringent UBBL building regulation for fire resistance for safety and has tested to MS 1073: Part3: 1996 (Amd I : 2003). Our product is listed under SIRIM's Product Certification Unit and carries the MS mark.

OCTOPUS Firedoors is an important element to any home, office, building and facilities. When people purchase doors, they often look at features such as style, design, cost and quality. However, a feature that is commonly overlooked is whether it is fireproof or not. We supply an amazing selection of firedoors that are stylish, excellent quality, secure, durable, and reliable and fire resistance. OCTOPUS Firedoors is an essential element are a great way to limit the risk of passive fire during a fire outbreak. It gives you a peace of mind that risk of the fire spreading is heavily reduced therefore keeping you, your family and your possessions safe.

OCTOPUS Firedoors are manufactured with various core specifications to meet the standards and requirements of the intended application. It features a solid core specification, containing a high density extruded fireboard panel. The main inner core of our doors is made of extruded high density fireboard thus, providing sound acoustic properties.

DOOR STANDARDS: • MS 1073: PART 3: 1996 (Amd I : 2003)







Octopus Marketing Sdn Bhd (1007299-x)
Lot 704, Batu 13, Kg. Sungai Rambai 42600 Jenjarom,
Kuala Langat, Selangor, Malaysia

+603 3191 6563 +6012 428 2150

+603 3191 3118

octo-firedoor.com